

ShenZhen Sintronic

Technology Company Limited



Tim Wu
Sales Engineer

 **SINTRONICTECH**
MAKE A DIFFERENCE

Address: No. 3368, Pengrunda Commercial Plaza Shenzhen City, China. 518000
Website: <https://sintronictech.com>
Email: tim@sintronictech.com
Mobile: +86-15813805304
China Leading Manufacturer Access & Security System

scan this code using the WhatsApp camera to get my number

Access Control, Turnstile Gate, Security Guard
Parking Guidance, Parking Ticketing System

Manufacturer



SINTRONIC TECH
 =====
 MAKE A DIFFERENCE

Shenzhen Sintronic Technology Company Limited

Access & Security System General Price List V5.0 For 2025

Sale Engineer: Tim Wu , Mobile/whatSapp&Wechat: +86-15813805304
 Email: tim@sintronictech.com

Access Control System



Page 3-41

Turnstile Gate System

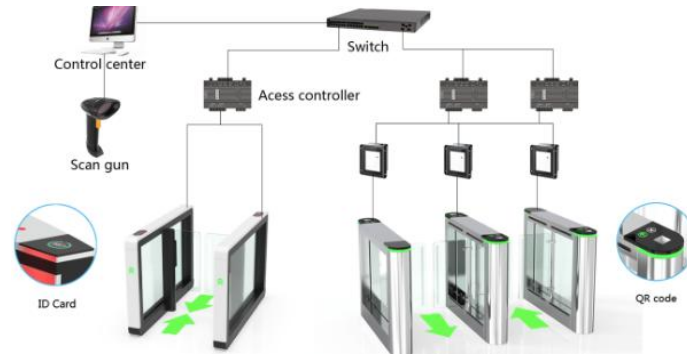

Page 42-51

Security Guard System



Page 52-60

Parking Guidance System

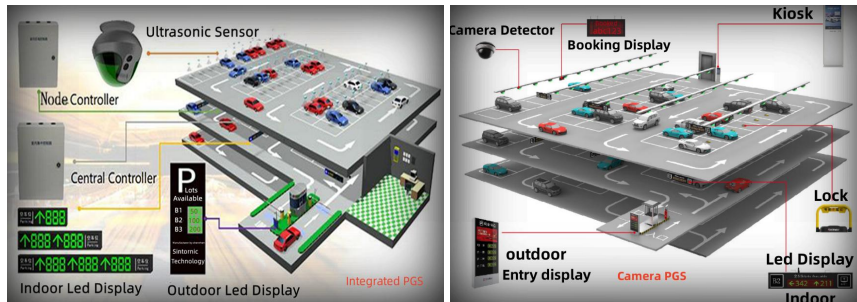

Page 61-70













Parking Ticketing System

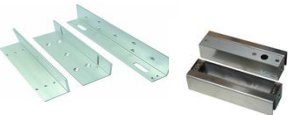



Page 71-79



Version 5.0 Update on 2024 August

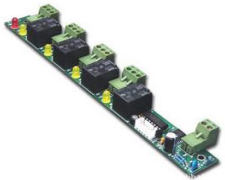

China Leading Access & Security System Manufacturer

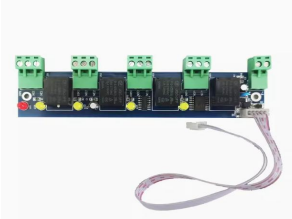

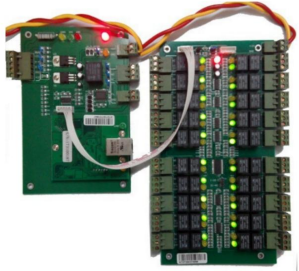

Access Control System Price List				
Access Control Manufacturing Department				
Website:sintronicaccess.com				
①				
Access Controller	Stand Alone Unit		RFID Reader	
				
Page 4-6	Page 7-14		Page 15-17	
Electronic Lock		Bracket	RFID Card	Remoter
				
Page 18-24		Page 25-27	Page 28-29	Page 30
Power Supply	Exit Button	Emergency Button	WIFI Electric Relay Module	Intelligent Lock
				
Page 31	Page 32-34	Page 35	Page 36-38	Page 39-41
1.Rfid Card Access Control 2.Biometric Fingerprint&Face Recognition Access Control 3.QR Bar Code Access Control 4.Wifi Access Control				





S/N	Name	Model	Picture	Technical Parameters	/	Link	Remark
Access Controller							
32Bit Series (LAN Remote Control,Web Control)							
1	Single Door Access Controller TCP/IP	32BIT01		Size:160*106mm Power Box Size:273mm*228mm*65mm Communication Model:TCP/IP Power Supply:12VDC 4-7A Reader Input Format:Wiegand26/34 Card Capacity:40,000 Units Record Capacity:100,000 Units Database available:Access,SQL2008 ,compatible with SQL2000,SQL2005 Software:Free	/	More Photo ->Click	1.Integrated functions of remote access,interlock,anti-pass,multi-card.,ect 2.V8.81 Version Software
2	2 Door Access Controller TCP/IP	32BIT02					
3	4 Door Access Controller TCP/IP	32BIT04					
4	Integrated Fire and Alarm Extend Board	32BIT-EXT		Four relay alarm output. Connectable to fire signal Input Time delay 0~6000 second adjustable Can control the illegal break-in alarm			





S/N	Name	Model	Picture	Technical Parameters	/	Link	Remark
64 Bit Series Premium (Barcode, Video Linkage)							
5	Single Door Access Controller TCP/IP	64BIT01		Size:160*106mm Power Box Size:273mm*228mm*65mm Communication Model:TCP/IP Power Supply:12VDC 4-7A Reader Input Format:Wiegand26-40 Card Capacity:40,000 Units Record Capacity:100,000 Units Database available:Access,SQL2008 ,compatible with SQL2000,SQL2005 Software:Free	/	More Photo ->Click	1.Special Functions Of Bar Code Access and Support Video interlinked to take screen shoot (Hivision Camera, 2.Option For OEM 4G 3.V8.5 Software
6	2 Door Access Controller TCP/IP	64BIT02					
7	4 Door Access Controller TCP/IP	64BIT04					
8	Integrated Fire and Alarm Extend Board	64BIT-EXT		Four relay alarm output. Connectable to fire signal Input Time delay 0~6000 second adjustable Can control the illegal break-in alarm			



S/N	Name	Model	Picture	Technical Parameters	/	Link	Remark
Elevator Controller							
9	20 Floors Elevator ,Cabinet Access Controller Tcp/Ip	EC20SET		Size:160*106mm Power Box Size:273mm*228mm*65mm Communication Model:TCP/IP Power Supply:12VDC 4-7A Reader Input Format:Wiegand26/34 Card Capacity:20,000 Units Record Capacity:100,000 Units Database available:Access,SQL2008 ,compatible with SQL2000,SQL2005 Software:Free Integrated functions of remote access,interlock,anti-pass,multi- card.,ect	/	More Photo ->Click	V8.81 Plus Version Software
10	20 Floors Elevator Extend Board	EXT20		<ul style="list-style-type: none"> ◆ 300DT20 Extend Board ◆ Output: 20 circuit 			



S/N	Name	Model	Picture	Technical Parameters	/	Link	Remark
Stand Alone Unit							
RFID Standalone Unit							
11	Outdoor Standalone Unit ID 125KHZ wg26	SA-RF01		Waterproof stand alone unit Material:ABS Plastic Card Capacity:16000cards Card Type :EM card Reading Range:5-8cm Operation Mode:Card Working Voltage:12V DC+-10% Dimension:86*86*64mm CE /FCC/ROSH Qualify		None	Without Key Pad
12	Outdoor Standalone Unit ID 125KHZ	SA-RF02		Waterproof stand alone unit Material:ABS Plastic Card Capacity:1000cards Card Type :EM card Reading Range:5-8cm Operation Mode:Card Working Voltage:12V DC+-10% Dimension:86*86*64mm CE /FCC/ROSH Qualify		None	Without Key Pad
13	Economical Standalone Unit ID 125KHZ (keypad)	SA-RF03KP		Waterproof stand alone unit Material:ABS Plastic Card Capacity:1000cards Card Type :EM card Reading Range:5-8cm Operation Mode:Card, Card+Password Working Voltage:12V DC+-10% Dimension:120*78*22 mm CE /FCC/ROSH Qualify		More Photo ->Click	IC Type USD9.9 Per Unit



S/N	Name	Model	Picture	Technical Parameters	/	Link	Remark
14	Standalone Unit (ID 125KHZ keypad)	SA-RF04KP		Waterproof stand alone unit Material:ABS Plastic Card Capacity:2000cards Card Type :EM card Reading Range:5-8cm Operation Mode:Card, Card+Password Working Voltage:12V DC+-10% CE /FCC/ROSH Qualify Dimension:108*78*20mm		None	luxuty design
15	Touch Screen Stand alone Unit (Keypad with Night vision)	SA-RF05KPT		Waterproof stand alone unit Material:ABS Plastic Card Capacity:1000cards Card Type :EM card Reading Range:5-8cm Operation Mode:Card, Card+Password Working Voltage:12V DC+-10% Dimension:121*57*20mm CE /FCC/ROSH Qualify		More Photo ->Click	IC Type USD15.9 Per Unit
16	Metallic stand alone unit id 125Khz	SA-RF06MKP		Waterproof stand alone unit Card Capacity:2000cards Card Type :EM card Reading Range:5-8cm Operation Mode:Card, Card+Password Working Voltage:12V DC+-10%	/	More Photo ->Click	CE /FCC/ROSH Qualify Dimension:140*58*27mm
17	Metalic stand alone unit id 125Khz	SA-RF07MKP		Waterproof stand alone unit Card Capacity:1000cards Card Type :EM card Reading Range:5-8cm Operation Mode:Card, Card+Password Working Voltage:12V DC+-10% Dimension:120*76*28mm		None	CE /FCC/ROSH Qualify



S/N	Name	Model	Picture	Technical Parameters	/	Link	Remark
18	Metalic Outdoor Waterproof stand alone unit	SA-RF08MKP		Waterproof stand alone unit Card Capacity:2000cards Card Type :EM card Reading Range:5-8cm Operation Mode:Card, Card+Password Working Voltage:12V DC+-10% CE /FCC/ROSH Qualify Dimension:120*76*28mm		None	CE /FCC/ROSH Qualify
19	Touch screen stand alone unit id 125Khz Wg26	SA-RF09MKP		Waterproof stand alone unit Card Capacity8000cards Card Type :EM card Reading Range:5-8cm Operation Mode:Card, Card+Password Working Voltage:12V DC+-10% Dimension:115*80*24mm		Working Voltage:12V DC+-10% CE /FCC/ROSH Qualify Dimension:115*80*24mm	CE /FCC/ROSH Qualify
20	Touch screen stand alone unit id 125Khz	SA-RF10MKP		Waterproof stand alone unit Card Capacity:4000cards Card Type :EM card Reading Range:5-8cm Operation Mode:Card, Card+Password Working Voltage:12V DC+-10% CE /FCC/ROSH Qualify Dimension:115*80*24mm		None	ID
21	NFC Dual Frequency ID+IC Standalone Unit	SA-NFC01		Waterproof stand alone unit Material:ABS Plastic Card Capacity:10000cards Card Type :EM card Reading Range:5-8cm Operation Mode:IC+ID Card, Card+Password Working Voltage:12V DC+-10% Dimension:121*57*20mm		None	125khz+13.56 Mhz Frequency



S/N	Name	Model	Picture	Technical Parameters	/	Link	Remark
Fingerprint Standalone Unit							
22	Fingerprint stand alone unit ID125KHZ	SA01Finger		Working voltage: DC12V Static current: <100ma Unlocking method: fingerprint, password, IC card Fingerprint type: semi -conductor collection module Storage capacity: 120 fingerprint 120 cards a set of general passwords Reading card distance: 3-5cm	/	None	Card reading mode: WG26 output Management card: You can set up adding cards and delete cards
23	Fingerprint stand alone unit ID 125KHZ Metallic	SA02Finger		Working voltage: DC12V Static current: <100ma Unlocking method: fingerprint, password, IC card Fingerprint type: semi -conductor collection module Storage capacity: 300 fingerprint 10000 cards a set of general passwords Reading card distance: 3-5cm Card reading mode: WG26 output		None	IC Tyoe is usd35.9
24	Fingerprint stand alone unit ID125KHZ ABS	SA03Finger		Power Supply: DC 9-12V < 100mA Read Card Distance: 0-60mm Fingerprint Capacity: 1000 Units Read Card Style:Fingerprint , EM Card Output signal: Wiegand 26 and can work as stand alone unit Size:155(L)×66(W)×28(H)(mm)		More Photo ->Click	IP65
25	Out Door Fingerprint stand alone unit with Remoter	SA04Finger		Power Supply: DC 9-12V < 100mA Read Card Distance: 0-60mm Fingerprint Capacity: 1000 Units EM Card Capacity:2000 Units Read Card Style:Fingerprint , EM Card Output signal: Wiegand 26 and can work as stand alone unit		More Photo ->Click	IP66



S/N	Name	Model	Picture	Technical Parameters	/	Link	Remark
Face Recognition Standalone Unit							
26	4.5 inch Dynamic Face Recognition Standalone Unit Tcp/ip Wg26	SA-0145FR		Input voltage:12DC Face store capacity 2000 Units Em card:2000units Password:2000 units Pixel:200W , Communication:TCP/IP Time attendance capacity:100,000 units One group of wiegand 26 signal		More Photo ->Click	/
27	5 inch Dynamic Face Recognition Standalone Unit Tcp/ip Wg26	SA-0150FR		Input voltage:12DC Face store capacity 2000/5000 Units Em card:2000units Password:2000 units Pixel:200W , Communication:TCP/IP Time attendance capacity:100,000 units One group of wiegand 26 signal		More Photo ->Click	/



S/N	Name	Model	Picture	Technical Parameters	/	Link	Remark
28	7 inch Dynamic Face Recognition Standalone Fingerprint 3 in 1 Unit Tcp/ip Wg26	SA-0170FR		Input voltage:12DC Face store capacity 2000 Units Fingerprint:10000 units Em card:2000units Password:2000 units Pixel:200W , Communication:TCP/IP Time attendance capacity:100,000 units One group of wiegand 26 signal	/	More Photo ->Click	/
29	Living Object Dual Face Recognition Standalone Unit Tcp/ip Wg26 For Turnstile Gate	SA-02FR		Input voltage:12DC Face store capacity:5000 Units Pixel:200W Wiegand26/34 output 1 unit of RJ45 10M/100M interface 2 units of switch signal output 1 unit of audio signal output 1 unit of alarm signal input 1 unit of RS485 interface 1 unit of two door access controller		More Photo ->Click	



S/N	Name	Model	Picture	Technical Parameters	/	Link	Remark
Mobile App Standalone Unit							
30	WIFI Standalone Unit Tuta App	SA-01APP		Waterproof and anti-disassembly Material:ABS Card Capacity:1000cards Control Type :EM card, APP Reading Range:5-8cm Operation Mode:Card, Card+Password Working Voltage:12V DC+-10% Can set up normal open period		None	CE /FCC/ROSH Qualify
31	WIFI Standalone Unit Tuta App	SA-02APP		Material:Metal Capacity:2000 Users Control Type :EM card,APP Reading Range:5-8cm Operation Mode:Card, Card+Password Working Voltage:12V DC+-10%		More Photo ->Click	CE /FCC/ROSH Qualify



S/N	Name	Model	Picture	Technical Parameters	/	Link	Remark
32	WIFI Standalone Unit Tuta App Fingerprint Em Card 3 in 1	SA-03APP		Waterproof and anti-disassembly Material: Metal Card Capacity: 1000 cards Control Type: EM card, Fingerprint, APP Reading Range: 5-8cm Operation Mode: Card, Card+Password Working Voltage: 12V DC+-10%	/	/	CE /FCC/ROSH Qualify
33	Cloud standalone unit IC 13.56MHZ (Bluetooth)	SA-01BT		Material: ABS Card Capacity: 1000 cards Control Type: EM card, Bluetooth, APP Reading Range: 5-8cm Operation Mode: Bluetooth, Card, Card+Password Working Voltage: 12V DC+-10% Cloud Base Option for wifi, 4g		More Photo ->Click	CE /FCC/ROSH Qualify



S/N	Name	Model	Picture	Technical Parameters	/	Link	Remark
RFID Reader							
34	RFID Reader Outdoor Waterproof id 125khz	Reader-01		Power Supply: DC 9-12V < 100mA Read Card Distance: 0-60mm Support: ID Card/125KHz Output signal:Wiegand 26bits/Wiegand 34 Size: 102×34×21mm Weight: 150g		None	Option For IC
35	RFID Reader id	Reader-02		RFID WIEGAND Reader For ID Card Power Supply: DC 9-12V < 100mA Read Card Distance: 0-60mm Support: ID Card/125KHz		None	Option For IC
36	RFID ReaderDual Frequency id 125khz +ic13.56mhz	Reader-Dual03		RFID WIEGAND Reader For ID Card Power Supply: DC 9-12V < 100mA Read Card Distance: 0-60mm Support: ID Card/125KHz+IC card13.56mhz		None	ID+IC



S/N	Name	Model	Picture	Technical Parameters	/	Link	Remark
37	EM Reader	Reader-Keypad04		WG26,EM Card Reader Power supply:DC12V Waterproof Size: 86×86×18 (mm)	/	More Photo ->Click	Option For IC
38	HID+EM+MIFARE Card Reader	Reader-HID05		Power Supply: DC 9-12V < 100mA Read Card Distance: 0-60mm Support: HID+EM+MIFARE Card Output signal: Wiegand 26bits/Wiegand 34 Size: 114×73×16mm Weight: 150g	/	None	HID+EM+IC Card
39	Barcode and IC card All in One Reader	Reader-Barcode06		Power Supply: DC 9-12V < 100mA Read Type:Paper barcode, Screen Barcode, IC card. USB Virtual Keypad. Interface:RS232,RS485,USB,Wiegand 26/ 34,RJ45	/	More Photo ->Click	/





S/N	Name	Model	Picture	Technical Parameters	/	Link	Remark
40	0-5 meter 915 UHF long range reader 7DB	READER-05UHF		<p>Work Frequency:902MHZ-----928MHZ Option for 865-870mHZ</p> <p>Work Model:Software setting frequency hopping or fixed frequency operation</p> <p>Support card: ISO 18000-6C (EPC Gen2)</p> <p>Full Interface: WG26/WG34/WG98, RS232/RS485, USB, TCP Standard</p> <p>Work current: 9V 150mA</p> <p>Size: 215mm × 215mm × 50mm</p> <p>Weight: 0.8kg</p>		None	Interface adding per module manufacturing cost is usd12 per extra interface such as usb,wg98,tcp/ip Interface:WG26 /WG34,RS485 OR RS232
41	0-10 meter 915 UHF long range reader	READER-10UHF		<p>Work Frequency:902MHZ-----928MHZ Option for 865-870mHZ</p> <p>Work Model:Software setting frequency hopping or fixed frequency operation</p> <p>Support card: ISO 18000-6C (EPC Gen2)</p> <p>Full Interface: WG26/WG34/WG98, RS232/RS485, USB, TCP Standard</p> <p>Interface:WG26/WG34,RS485 OR RS232</p> <p>Card reading distance: 0-5m (high power 0-8m)</p> <p>Working frequency: 915MHz</p> <p>Work current: 9V 150mA</p> <p>Size: 257mm × 257mm × 42mm</p> <p>Weight: 1.45kg</p>		None	Interface adding per module manufacturing cost is usd12 per extra interface such as usb,wg98,tcp/ip



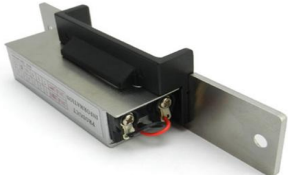

S/N	Name	Model	Picture	Technical Parameters	/	Link	Remark
Electronic Lock							
Drop Bolt Lock							
42	2 cable drop bolt lock Mortise	BL-102		Standard Electric Bolt (2-core cable) Type: Fail safe Lock Size: 204×36×42mm Working Voltage: DC 12V±10% Support Door :wooden door/glass door/metal door/ fire-escape door Material: Aluminum/stainless steel Weight: 0.5kg		More Photo ->Click	2 cable
43	5 cable drop bolt lock Mortise low temperature with signal output and time delay	BI-105		Standard Electric Bolt (5-core cable) Type: Fail safe Lock Size: 204×36×42mm (NO, NC, COM) Working Voltage: DC 12V±10% Support Door :wooden door/glass door/metal door/ fire-escape door Material: Aluminum/stainless steel Weight: 0.7kg		More Photo ->Click	NO/NC/COM



S/N	Name	Model	Picture	Technical Parameters	/	Link	Remark
44	5 cable drop bolt lock low temperature with signal output and time delay	BL-205Narrow		Standard Electric Bolt (5-core cable) Type: Fail safe Lock Size: 205×35×42mm (NO, NC, COM) Working Voltage: DC 12V±10% Support Door :wooden door/glass door/metal door/ fire-escape door Material: Aluminum/stainless steel Weight: 0.7kg	/	None	NO/NC/COM
45	6 cable drop bolt lock low temperature with signal output and time delay	BL-206Narrow		Standard Electric Bolt (6-core cable) Type: Fail Secure Lock Size: 204×36×42mm (NO, NC, COM) Working Voltage: DC 12V±10% Support Door :wooden door/glass door/metal door/ fire-escape door Material: Aluminum/stainless steel Weight: 0.7kg	/	None	low temperature with signal output and time delay





S/N	Name	Model	Picture	Technical Parameters	/	Link	Remark
46	9 cable drop bolt lock low temperature with signal output and time delay	BL-209Narrow		<p>Standard Electric Bolt (6-core cable) Type: Fail Secure Lock Size: 205×35×42mm (NO, NC, COM) Working Voltage: DC 12V±10% Support Door :wooden door/glass door/metal door/ fire-escape door Material: Aluminum/stainless steel Weight: 0.7kg</p>		None	Low temperature with signal output and time delay
47	Surface Mounted drop bolt lock low temperature with signal output and time delay	BL-304Mounted		<p>Standard Electric Bolt (4-core cable) Type: Fail safe (NO/NC, COM) Working Voltage: DC 12V±10% Support Door :wooden door/glass door/metal door/ fire-escape door Material: Aluminum/stainless steel Weight: 0.7kg</p>		None	Low temperature with signal output and time delay
48	Frameless drop bolt lock with time delay	BL-404 Frameless		<p>Power Supply:12V DC Output contact:NO/NC/COM Time delay adjustable:0,3,6 seconds Suitable for glass door thickness from 8-12mm</p>		None	Time delay



S/N	Name	Model	Picture	Technical Parameters	/	Link	Remark
Strike Lock							
49	Narrow Panel Drop Bolt Strike Lock	SL-102 Narrow		Lock Size: 129×28×34mm Type: Fail safe, can be customized fail secure Working Voltage: DC 12V±10% Support Door: Wooden door/metal door Face plate Housing: Painted steel Material: Aluminum/stainless steel Weight: 0.35 kg	US\$12.90	US\$12.60	None /
50	Long Panel Drop Bolt Strike Lock	SL-102 Long		Lock Size: 250×25×31mm Type: Fail Safe, can be customized fail secure Working Voltage: DC 12V±10% Support Door: Wooden door/metal door Face plate Housing: Painted steel Material: Aluminum/stainless steel NO,NC,COM Weight: 0.35 kg	US\$12.90	US\$12.60	None /
51	Narrow Panel Drop Bolt Strike Lock with signal feedback	SL-105 Narrow		Lock Size: 129×28×34mm Type: Fail safe, can be customized fail secure Working Voltage: DC 12V±10% Support Door: Wooden door/metal door Face plate Housing: Painted steel Material: Aluminum/stainless steel Weight: 0.35 kg	US\$13.90	US\$13.60	None /



S/N	Name	Model	Picture	Technical Parameters	/	Link	Remark
Magnetic Lock							
180KG / 350-450 LBS							
52	Single Door Electro-Magnetic Lock (180KG)	Mag-180		Type: Fail Safe, without signal feedback U/I: DC12V/300MA Size: L170*W42*H21MM	/	More Photo ->Click	2 cable
53	Single Door Electro-Magnetic Lock (180KG) with signal feedback	Mag-180Signal		Type: Fail Safe, signal feedback U/I: DC12V/300MA Size: L170*W42*H21MM		More Photo ->Click	NO/NC/COM
54	Two Door Electro-magnetic Lock (180KG×2)	Mag-1802		Type: Fail Safe, without signal feedback U/I: DC12V/300MA Size: L340*W42*H21MM		More Photo ->Click	/
55	Two Door Electro-magnetic Lock (180KG×2) with signal feedback	Mag-1802Signal		Type: Fail Safe, signal feedback U/I: DC12V/300MA Size: L340*W42*H21MM		More Photo ->Click	NO/NC/COM





S/N	Name	Model	Picture	Technical Parameters	/	Link	Remark
280KG/550-650 LBS							
56	One-door Electro-magnetic Lock (280KG)	Mag-280		Type: Fail Safe, without singnal output U/I: DC12V/460MA Size: L250*W47*H25MM	/	More Photo ->Click	/
57	One-door Electro-magnetic Lock With signal feedback(280KG)	Mag-280Signal		Type: Fail Safe, with singnal output ,with time delay U/I: DC12V/460MA Size: L250*W47*H25MM		More Photo ->Click	NO/NC/COM
58	Two Door Electro-magnetic Lock (280KG×2)	Mag-2802		Type: Fail Safe, without singnal Feedback U/I: DC12V/460MA Size: L500*W47*H25MM		More Photo ->Click	/
59	Two Door Electro-magnetic Lock With signal feedback (280KG×2)	Mag-2802Signal		Type: Fail Safe, without singnal Feedback U/I: DC12V/460MA Size: L500*W47*H25MM		More Photo ->Click	NO/NC/COM





S/N	Name	Model	Picture	Technical Parameters	/	Link	Remark
380KG/750-900 LBS							
60	One-door Electro-magnetic Lock (350KG)	Mag-380		Type: Fail Safe, without singnal Feedback U/I: DC12V/480MA Size: L285*W55*H29MM	/	More Photo ->Click	2 cable
61	One-door Electro-magnetic Lock LED Indication Light(500KG)	Mag-380Signal		Type: Fail Safe, without singnal Feedback U/I: DC12V/480MA Size: L285*W55*H29MM		More Photo ->Click	NO/NC/COM





S/N	Name	Model	Picture	Technical Parameters	/	Link	Remark
Lock Bracket							
62	L Type Bracket For 180KG Magnetic Lock	Bracket-Mag180L		Support Door: Wooden door open toward inside, metal door, narrow frame door Door Open Mode: 90 degree one-way, Weight:0.318kg Material: Aluminum Size: 265*65*60mm		More Photo ->Click	L- 180KG
63	L Type Bracket For 280KG Magnetic Lock	Bracket-Mag280L		Support Door: Wooden door open toward inside, metal door, narrow frame door Door Open Mode: 90 degree one-way, Weight:0.318kg Material: Aluminum Size: 265*65*60mm		More Photo ->Click	L-280KG
64	U Type Bracket For Magnetic Lock of 180KG ,280KG	Bracket-Mag180U		Support Door: Frameless glass door Glass Thickness: 8~5mm Door Open Mode: 180 degree one-way, Weight: 0.242kg Material: Aluminum Size: 105*60*45mm		More Photo ->Click	U-180KG
65	U Type Bracket For Magnetic Lock of 180KG ,280KG	Bracket-Mag280U		Support Door: Frameless glass door Glass Thickness: 8~5mm Door Open Mode: 180 degree one-way, Weight: 0.242kg Material: Aluminum Size: 105*60*45mm		More Photo ->Click	U-280KG





S/N	Name	Model	Picture	Technical Parameters	/	Link	Remark
66	LZ Type Bracket For Magnetic Lock of 180KG	Bracket-Mag180LZ		Support Door: Wooden door open toward inside, metal door, narrow frame door Door Open Mode:90 degree one-way, Weight:0.718kg Material: Aluminum Size: 270*60*60mm	/	More Photo ->Click	LZ-180KG
67	LZ Type Bracket For Magnetic Lock of 280KG	Bracket-Mag280LZ		Support Door: Wooden door open toward inside, metal door, narrow frame door Door Open Mode:90 degree one-way, Weight:0.718kg Material: Aluminum Size: 270*60*60mm	/	More Photo ->Click	LZ-280KG
68	70mm oval hole Bracket	Bracket-BL70		Material:Aluminum Door Type Applicable:Bottom Frameless Glass Door Door-open Mode:180 Degree One-way Open Support Lock: Drop Bolt Type		None	Bolt Lock Bracket





S/N	Name	Model	Picture	Technical Parameters	/	Link	Remark
69	80mm Round Hole Bracket	Bracket-BL80		Material:Aluminum • Door Type Applicable:Bottom Frameless Glass Door • Door-open Mode:180 Degree One-way Open Support Lock: Drop Bolt Type		None	Bolt Lock Bracket
70	U Bracket For Drop Bolt Lock	Bracket-BL U		• Material:stainless steel • Door Type Applicable:Bottom Frameless Glass Door • Door-open Mode:180 Degree One-way Open Support Lock: Drop Bolt Type		None	Bolt Lock Bracket
71	ZL Bracket For Drop Bolt Lock	Bracket-BL-ZL		Material:stainless steel Door Type Applicable:Frameless Glass Door Door-open Mode:180 Degree Two-way Open Support Lock: Drop Bolt Type		None	Bolt Lock Bracket 2pcs is one set





S/N	Name	Model	Picture	Technical Parameters	/	Link	Remark
RFID Card							
72	EM White Card	Card-125K		125KHZ, WHITE		More Photo ->Click	EM
73	Mifare White Card	Card-1356M		13.56MHZ WHITE		More Photo ->Click	MIFARE
74	Key chain mifare card	Card-1356MKC		Material:ABS Frequency:13.56MHZ		More Photo ->Click	MIFARE
75	Wrist band Em Card	Card-125kWrist		RFID wrist band 125khz 100		More Photo ->Click	EM





S/N	Name	Model	Picture	Technical Parameters	/	Link	Remark
76	HID CARD	Card-HID		HID CARD FOR 26 34 ACCESS CONTROLLER	/	More Photo ->Click	HID
77	UHF Card	Card-UHF01		Uhf Card work for uhf long range reader		More Photo ->Click	/
78	UHF Sticker Windshield	Sticker -UHF/WS		UHF Sticker Windshield		More Photo ->Click	/
79	USB UHF CARD DISTRIBUTOR	DST-100UHF		Read and Write uhf card bumber		None	DESK TOP



S/N	Name	Model	Picture	Technical Parameters	/	Link	Remark
Remoters							
80	2 Button Remote Exit Control (copy /learning type)	RB-102Button		Power Supply:Button Battery Working Current:<=12mA Frequency:Adopt 433MHZ Emission Frequency Option For 315 and other wireless frequency Distance 30-100m Work way:Jog,Self-locking,Interlock		More Photo ->Click	Distance 30-100m
81	2 Channel Economical remote set (exit control+remote r)	RB-102Set		Power Supply:12V DC Working Current:<=12mA Frequency:Adopt 433MHZ Emission Frequency Option For 315 and other wireless frequency Distance 30-100m Work way:Jog,Self-locking,Interlock		More Photo ->Click	Distance 30-100m
82	4 Button Remote Exit Control (copy /learning type)	RB-204Button		Power Supply:Button Battery Working Current:<=12mA Frequency:Adopt 433MHZ Emission Frequency Option For 315 and other wireless frequency Distance 30-105m Work way:Jog,Self-locking,Interlock	/	More Photo ->Click	Distance 30-100m
83	4 Channel Remote set (exit control+remote r)	RB-204Set		Power Supply:12V DC Working Current:<=12mA Frequency:Adopt 433MHZ Emission Frequency Option For 315 and other wireless frequency Distance 30-100m Work way:Jog,Self-locking,Interlock		More Photo ->Click	Distance 30-100m



S/N	Name	Model	Picture	Technical Parameters	/	Link	Remark
Power Supply							
84	Special Power Supply for stand alone unit	Power-1203		Input:220V AC Output:12V DC, 3A/5A Time adjust:1S-10S NO/NC/COM	/	None	/
85	Power supply with metallic outdoor cover For access controller	Power-1205		Power supply with metallic cover Input voltage: 220—250VAC (OEM For 110VAC) Output voltage: 12VDC 3/5A can connect with recharge battery and with circuit protection Size:277mm*233mm*66mm Low voltage protection function double panel and durable		None	/
86	Power supply with metallic outdoor cover(Support Inner connect UPS battery)	Power-1205 Mini		Power supply with metallic cover Input voltage: 220—250VAC (OEM For 110VAC) Output voltage: 12VDC 3/5A can connect with recharge battery and with circuit protection 155mm*77mm*52mm		None	/
87	Special Power Supply for stand alone unit	PB-1203		Input:220V AC Output:12V DC, 3A/5A Time adjust:1S-15S NO/NC/COM		More Photo ->Click	12V3A
88	Power supply with metallic outdoor cover(Support Inner connect UPS battery)	PB-1205Plus		Power supply with metallic cover Input voltage: 220—250VAC (OEM For 110VAC) Output voltage: 12VDC 3/5A can connect with recharge battery and with circuit protection Size:372mm*263mm*70mm		More Photo ->Click	Low voltage protection function double panel and durable Battery is not included

S/N	Name	Model	Picture	Technical Parameters	/	Link	Remark
Exit Button							
89	Plastic I RFID Exit Button	Exit-01P		Electric Parameter: Max. current 3A@36VDC Contact Output: COM/NO Material: Plastic Size: 86×86×20mm		More Photo ->Click	/
90	Stainless Steel RFID Exit Button	Exit-02SSL		Exit Button(Stainless Steel) Size:86*28CM Electric Parameter:3A 36V DC MAX Working Voltage:12V DC+-10% Output contact:NO/COM Suitable For:Break Glasses in case of emergency Suitable For:Hollow Frame and Embeded Electric Case		More Photo ->Click	/
91	Stainless Steel RFID Exit Button	Exit-02SSB		Exit Button(Stainless Steel) Size:86*86CM Electric Parameter:3A 36V DC MAX Working Voltage:12V DC+-10% Output contact:NO/ COM Suitable For:Hollow Frame and Embeded Electric Case		More Photo ->Click	/
92	RFID Exit Button (Night Vision)	Exit-03NVL		Door Release Button(Night Luminums) Size:86*28CM Electric Parameter:3A 36V DC MAX Working Voltage:12V DC+-10% Output contact:NO/ COM Suitable For:Hollow Frame and Embeded Electric Case		More Photo ->Click	/



S/N	Name	Model	Picture	Technical Parameters	/	Link	Remark
93	RFID Exit Button (Night Vision)	Exit-03NVB		Door Release Button(Night Luminums) Size:86*86CM Electric Parameter:3A 36V DC MAX Working Voltage:12V DC+-10% Output contact:NO/ COM Suitable For:Hollow Frame and Embeded Electric Case		More Photo ->Click	/
94	Aluminum RFID Exit Button	Exit-04ALU		Electric Parameter: Max. current 3A@36VDC Contact Output: COM/NO Material: Aluminum Size: 86*50**20mm		More Photo ->Click	/
95	Aluminum RFID Exit Button	Exit-04ALUB		Electric Parameter: Max. current 3A@36VDC Contact Output: COM/NO/NC Material: Aluminum Size: 86×86×20mm	/	More Photo ->Click	/
96	Lock Key RFID Exit Button	Exit-05Key		Size:86*86*20mm Electric Parameter:3A/36V Dc max Output contact:NO/NC/COM Suitable for hollow Frame and embeded electric case		More Photo ->Click	NO/NC/COM

S/N	Name	Model	Picture	Technical Parameters	/	Link	Remark
97	Mushroom RFID Exit Button	Exit-06Mushroom		Size:86*86*20mm Electric Parameter:3A/36V Dc max Output contact:NO/NC/COM Suitable for hollow Frame and embeded electric case		More Photo ->Click	NO/NC/COM
98	Touch RFID Exit Button	Exit-07TB		Exit Button(Touch) Working Voltage:12V DC+-10% Size:86*86*20CM Electric Parameter:3A 36V DC MAX Output contact:NO/NC Suitable For:Hollow Frame and Embeded Electric Case		More Photo ->Click	NO/NC/COM
99	RFID Exit Button(IR)	Exit-L08IR		Electric Parameter: Max. current 3A@36VDC Contact Output: COM/NO/NC Material: Stainless steel Size: 113×68×30mm		More Photo ->Click	COM/NO
100	RFID Exit Button(IR)	Exit-B08IR		Electric Parameter: Max. current 3A@36VDC Contact Output: COM/NO/NC Material: Stainless steel Size: 86×86×30mm		More Photo ->Click	COM/NO

S/N	Name	Model	Picture	Technical Parameters	/	Link	Remark
Emergency Exit Button							
101	Glass Break Emergency Exit Button	Emg-101Glass		Break glass in case of emergency Contact output: NO/NC/COM Material: Plastic Size: 86×86×50mm		More Photo ->Click	Glass Break
102	Glass Break Double Pole Emergency Exit Button	Emg-102Glass		Double Pole Emergency Exit Button Size:86*86*20CM Electric Parameter:3A 36V DC MAX Working Voltage:12V DC+-10% Output contact:NO/NC/COM Suitable For:Break Glasses in case of emergency	/	More Photo ->Click	Double Pole
103	Push Rest Emergency Exit Button Single Pole	Emg-101RT		Emergency Push Exit Button Single Pole Contact output: NO/NC/COM Material: Plastic Size: 86×86×50mm		More Photo ->Click	Resettable

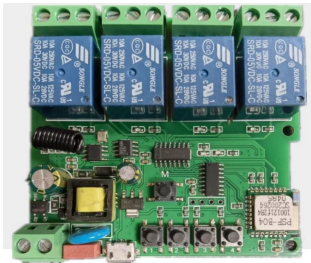
S/N	Name	Model	Picture	Technical Parameters	/	Link	Remark
WIFI Electric Relay Module/Signal Breaker							
104	DC5V WIFI Electric Relay Module Single Channel (Only 1 Set NO,NC,COM)	RELAY01		<p>[Product Name]: Signal Breaker Support 433 remoter connection Power Supply:AC85-250V [Output Voltage]: DC5-32V/USB5V [Product size]: 71 * 42 * 18mm (bare board) 72 * 45 * 29mm (with shell) 【 Wireless Type 】 : WI-FI2.4GHz Maximum load: 10A Wireless Standard: IEEE802.11 b/g/n [Operating environment]: Temperature -20~40 ℃</p>		None	/
105	DC5-32V WIFI Electric Relay Module Single Channel (Only 1 Set NO,NC,COM)	RELAY02		<p>[Product Name]: Signal Breaker Support 433 remoter connection Power Supply:AC85-250V [Output Voltage]: DC5-32V/USB5V [Product size]: 71 * 42 * 18mm (bare board) 72 * 45 * 29mm (with shell) 【 Wireless Type 】 : WI-FI2.4GHz Maximum load: 10A Wireless Standard: IEEE802.11 b/g/n [Operating environment]: Temperature -20~40 ℃</p>		None	/







S/N	Name	Model	Picture	Technical Parameters	/	Link	Remark
106	DC5-32V WIFI Electric Relay Module With Cover Single Channel (Only 1 Set NO,NC,COM)	RELAY03		[Product Name]: Signal Breaker Support 433 remoter connection Power Supply:AC85-250V [Output Voltage]: DC5-32V/USB5V [Product size]: 71 * 42 * 18mm (bare board) 72 * 45 * 29mm (with shell) 【 Wireless Type 】 : WI-FI2.4GHz Maximum load: 10A Wireless Standard: IEEE802.11 b/g/n [Operating environment]:	/	None	/
107	DC5-32V WIFI Electric Relay Module 4 Channels (4 SetsNO,NC,COM)	RELAY04		[Product Name]: Signal Breaker Support 433 remoter connection Power Supply:AC85-250V [Output Voltage]: DC5-32V/USB5V [Product size]: 71 * 42 * 18mm (bare board)*4 【 Wireless Type 】 : WI-FI2.4GHz Maximum load: 10A Wireless Standard: IEEE802.11 b/g/n [Operating environment]:	/	None	/



S/N	Name	Model	Picture	Technical Parameters	/	Link	Remark
108	DC5-32V WIFI Electric Relay Module With Cover With Remoter 4 Channels (4 SetsNO,NC, COM)	RELAY04B		[Product Name]: Signal Breaker Support 433 remoter connection Power Supply:AC85-250V [Output Voltage]: DC5- 32V/USB5V [Product size]: 71 * 42 * 18mm (bare board)*4 【 Wireless Type 】 : WI- FI2.4GHz Maximum load: 10A Wireless Standard: IEEE802.11 b/g/n [Operating environment]: Temperature -20~40 °C		None	/
109	DC5-32V WIFI Electric Relay Module With Cover 4 Channels (4 SetsNO,NC, COM)	RELAY04C		[Product Name]: Signal Breaker Support 433 remoter connection Power Supply:AC85-250V [Output Voltage]: DC5- 32V/USB5V [Product size]: 71 * 42 * 18mm (bare board)*4 72 * 45 * 29mm*4 (with shell) 【 Wireless Type 】 : WI- FI2.4GHz Maximum load: 10A Wireless Standard: IEEE802.11 b/g/n [Operating environment]: Temperature -20~40 °C		None	/
110	Wifi to 43mhz RF bridge	BRIDGE-RF01		Power Supply: Micro USB 5V/1A Supported Radio: 315 & 433MHz RF Not support to learn rolling code and dynamic code Wireless Standard: 2.4G-WiFi 802.11 b/g/n Security Mechanism: WPA- PSK/WPA2-PSK		None	/



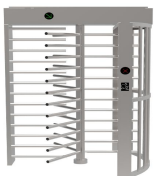

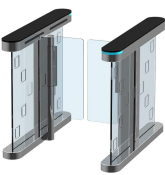
S/N	Name	Model	Picture	Technical Parameters	/	Link	Remark	
Intelligent Lock								
111	Fingerprint Door Lock TUYA WIFI	iL-Finger01		Quiescent current : $\leq 50\mu A$ Dynamic current : $\leq 180mA$ administrators : 10 groups fingerprints :50 groups Fingerprint + password + card capacity :250 groups Rejection rate $\leq 0.1\%$ False admission rate $\leq 0.0001\%$ Induction time ≤ 0.5 seconds Power supply type :6V Emergency power supply Typec 5V2A working temperature $-25^{\circ}C$ $\sim 60^{\circ}C$ Working relative humidity 20%~90%RH Low voltage alarm voltage 4.8 \pm 0.2V			None	/

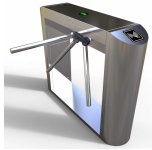
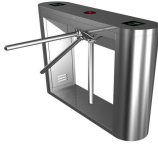
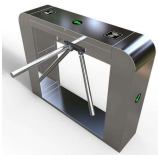

S/N	Name	Model	Picture	Technical Parameters	/	Link	Remark
112	Door Lock with Camera Wifi Tuya Bluetooth Door Bell Password Smart Door Lock Handle	iL-FACE01		Product Material Aluminum Alloy Lock Body 6068 Mortise Lock Size 390mm*75mm*75mm Network WIFI, Bluetooth User Capacity Fingerprint:100,Card+Password: 200 Function 11 language system Settings, 4.5 inch electronic screen, 1 million pixels,IPS screen TUYA View function, Emergency charging port, Free handle Design, Unlocking via mechanical key, IP56 dustproof and waterproof Door Type Wooden doors, iron doors, stainless steel doors, copper doors, aluminum doors, gates, metal doors	/	None	/

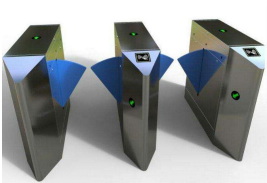

S/N	Name	Model	Picture	Technical Parameters	/	Link	Remark
113		iL-FACE03		Face recognition + video intercom Size:388*76*22mm Material:High-strength aluminum alloy + IMD touch screen+ LED screen Color:Grey Unlocking mode Fingerprints, passwords, IC cards, faces, mechanical keys, WeChat applets, mobile APP, remote unlocking and capture Register capacity Face Capacity 100 (10 admins + 90 regular users) Fingerprint Capacity: 50 (10 Admins + 40 Admins) Password Capacity 110 (102 administrators + 8 ordinary users) Card Capacity 100 (ordinary users), 10 groups of administrators, and 90 groups of ordinary users Adaptive door thickness 40-120MM door thickness Battery Comes with a lithium battery; 4200 mAh Fingerprint head Semiconductor, fingerprint head Lock cylinder Class c true lock		None	/



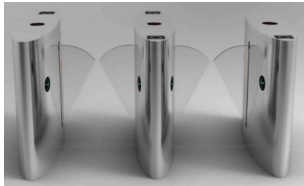
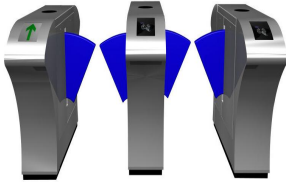
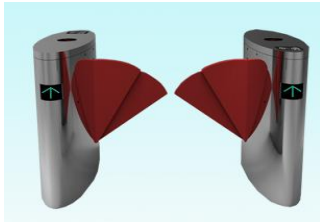

S/N	Name	Model	Picture	Technical Parameters	/	Link	Remark
②							
	Turnstile Gate Manufacturing Department sintronicturnstile.com						
	Turnstile Gate Price List						
Vertical Tripod		Long Bridge Tripod		Wing Turnstile	Half Height Turnstile	Full Height Turnstile	
							
Page 43				Page 44-45		Page 46-47	
Swing Turnstile					Sliding Turnstile		Speed Turnstile
							
Page 48-49					Page 50		Page 51
1、Compatible with IC/ID,Magnetic card ,Barcode ,ESD and various Device 2、Brake rod stable runing without noisy voice and fast open 3、Comply with fire alarm function with emmergency power off function 4、Control chip board with memory and accounting function(OPTION) 5、Standard input and output interface for acce ss control solutions reserved by https://sintronictech.com							

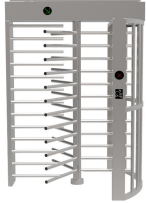

S/N	Name	Model	Picture	Technical Parameters	/	Link	Remark
Tripod Turnstile							
114	Vertical Tripod Turnstile	TP-VT01		Material:304 Stainless steel Single Core Size: 420x333x980mm Double Core Size:420x450x980mm Input Voltage: 110/220VAC,50HZ Entrance Width:≤550mm Service Life:≥5 million times	/	More Photo - >Click	Single Machine Core
		TP-VT02				More Photo - >Click	Double Machine Core
115	Tripod turnstile Octangle	TP-L01		Material:304 Stainless steel Size: 1200*280*980mm Input Voltage: 110/220VAC,50HZ Entrance Width:≤550mm Service Life:≥5 million times		More Photo - >Click	Single Machine Core
116	Tripod Turnstile Half Cover Arc	TP-L02		Material:304 Stainless steel Size: 1200*280*980mm Input Voltage: 110/220VAC,50HZ Entrance Width:≤550mm Service Life:≥5 million times		More Photo - >Click	Single Machine Core
117	Tripod Turnstile Whole cover arc	TP-L03		Material:304 Stainless steel Size: 1200*280*980mm Input Voltage: 110/220VAC,50HZ Entrance Width:≤550mm Service Life:≥5 million times1		None	Single Machine Core
118	Tripod turnstile Arched	TP-L04		Material:304 Stainless steel Size: 1200*280*980mm Input Voltage: 110/220VAC,50HZ Entrance Width:≤550mm Service Life:≥5 million times		More Photo - >Click	Single Machine Core

S/N	Name	Model	Picture	Technical Parameters	/	Link	Remark
Wing Turnstile							
119	Wing Turnstile Gates Half Cover Arc	WING101		Material:304 Stainless steel Size: 1200*280*980mm Input Voltage: 110/220VAC,50HZ Entrance Width:≤550mm Service Life:≥5 million times		More Photo - >Click	Single Machine Core
		WING102					Double Machine Core
120	Wing Turnstile Gates Octangle	WING103		Material:304 Stainless steel Size: 1200*280*980mm Input Voltage: 110/220VAC,50HZ Entrance Width:≤550mm Service Life:≥5 million times		More Photo - >Click	Single Machine Core
		WING104					Double Machine Core
121	Wing Turnstile Gates Sharp Angel	WING201		Material:304 Stainless steel Size: 1200*280*980mm Input Voltage: 110/220VAC,50HZ Entrance Width:≤550mm Service Life:≥5 million times		More Photo - >Click	Single Machine Core
		WING202					Double Machine Core
122	Wing Turnstile Gates Drum Type	WING301		Material:304 Stainless steel Size: 1200*280*980mm Input Voltage: 110/220VAC,50HZ Entrance Width:≤550mm Service Life:≥5 million times		More Photo - >Click	Single Machine Core
		WING302					Double Machine Core



S/N	Name	Model	Picture	Technical Parameters	/	Link	Remark
123	Wing Turnstile Gates Egg Type	WING401		Material:304 Stainless steel Size: 1200*280*980mm Input Voltage: 110/220VAC,50HZ Entrance Width:≤550mm Service Life:≥5million times	/	More Photo - >Click	Single Machine Core
		WING402					Double Machine Core
124	Wing Turnstile Gates Butterfly Type	WING501		Material:304 Stainless steel Size: 1200*280*980mm Input Voltage: 110/220VAC,50HZ Entrance Width:≤550mm Service Life:≥5 million times	/	None	Single Machine Core
		WING502					Double Machine Core
125	Double Wing Turnstile Gates Egg Type	WING601		Material:304 Stainless steel Size: 1200*280*980mm Input Voltage: 110/220VAC,50HZ Entrance Width:≤900mm Service Life:≥5million times	/	None	Single Machine Core
		WING602					Double Machine Core
126	Wing Turnstile Gates Boat Type	WING701		Material:304 Stainless steel Size: 1200*280*980mm Input Voltage: 110/220VAC,50HZ Entrance Width:≤550mm Service Life:≥5million times	/	None	Single Machine Core
		WING702					Double Machine Core



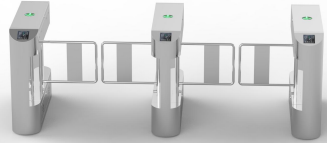
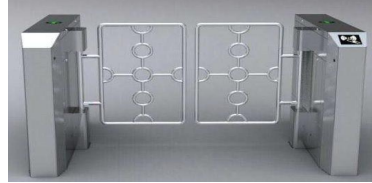

S/N	Name	Model	Picture	Technical Parameters	/	Link	Remark
Half Height Turnstile							
127	Half Height Turnstile	HALF01		SizeMaterial:304 Stainless steel Size: :1500*1200*280mm Input Voltage: 110/220VAC,50HZ Service Life:≥5million times	/	More Photo - >Click	Single Machine Core
Full Height Turnstile Gate							
128	One way Full Height Turnstile 90 Degree Head	FULL90		SizeMaterial:304 Stainless steel Size: :1630*1500*2300 Input Voltage: 110/220VAC,50HZ Service Life:≥5million times			Single Machine Core
129	One way Full Height Turnstile 120 degree head	FULL120		SizeMaterial:304 Stainless steel Size: :1600*1500*2300 Input Voltage: 110/220VAC,50HZ Service Life:≥5million times			Single Machine Core

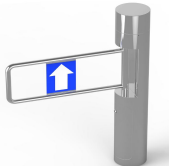

S/N	Name	Model	Picture	Technical Parameters	/	Link	Remark
130	One way Full Height Turnstile Square Head	FULL101		SizeMaterial:304 Stainless steel Size: :1450*1450*2300 Input Voltage: 110/220VAC,50HZ Service Life:≥5million times	/	More Photo ->Click	Single Machine Core
131	2 way Full Height Turnstile Square Head	FULL102		SizeMaterial:304 Stainless steel Size: :1450*2300*2300 Input Voltage: 110/220VAC,50HZ Service Life:≥5million times	/		Single Machine Core
132	2 way Full Height Turnstile Arched Head	FULL202		SizeMaterial:304 Stainless steel Size: :1300*2300*2200 Input Voltage: 110/220VAC,50HZ Service Life:≥6million times	/		Single Machine Core
133	3 way Full Height Turnstile Arched Head	FULL301		SizeMaterial:304 Stainless steel Size: :1400*2300*2200 Input Voltage: 110/220VAC,50HZ Service Life:≥6million times	/		Single Machine Core





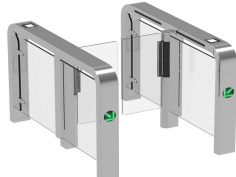
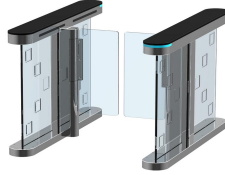

S/N	Name	Model	Picture	Technical Parameters	/	Link	Remark
Swing Turnstile							
134	Swing Turnstile Gates Octangle	SWING101		Material:304 Stainless steel Size: 1200*280*1000mm Input Voltage: 110/220VAC,50HZ Entrance Width:≤850mm Service Life:≥5 million times			Single Machine Core
		SWING102					Double Machine Core
135	Swing Turnstile Gates Half Cover Arc	SWING201		Material:304 Stainless steel Size: 1200*280*1000mm Input Voltage: 110/220VAC,50HZ Entrance Width:≤850mm Service Life:≥5million times			Single Machine Core
		SWING202					Double Machine Core
136	Swing Turnstile Gates Round Arc Gap	SWING301		Material:304 Stainless steel Size: 1200*280*1000mm Input Voltage: 110/220VAC,50HZ Entrance Width:≤850mm Service Life:≥5million times			Single Machine Core
		SWING302					Double Machine Core
137	Swing Turnstile Gates Carve	SWING401		Material:304 Stainless steel Size: 1400*280*1000mm Input Voltage: 110/220VAC,50HZ Entrance Width:≤650mm Service Life:≥5million times			Single Machine Core
		SWING402					Double Machine Core



[More Photo ->Click](#)



S/N	Name	Model	Picture	Technical Parameters	/	Link	Remark
138	Mini Acrylic Flap Swing Turnstile Gates Whole Cover Arc	SWING501		Material:304 Stainless steel Size: 1200*200*1000 Input Voltage: 110/220VAC,50HZ Entrance Width:≤370mm Service Life:≥5million times	/		Single Machine Core
		SWING502					Double Machine Core
139	Mini Acrylic Flap Swing Turnstile Gates Bevel ARC	SWING601		Material:304 Stainless steel Size: 1200*200*1000 Input Voltage: 110/220VAC,50HZ Entrance Width:≤370mm Service Life:≥5million times	/		Single Machine Core
		SWING602					Double Machine Core
140	Swing Turnstile Gates Vertical	SWING01		Material:304 Stainless steel Size:420*330*1000MM Input Voltage: 110/220VAC,50HZ Entrance Width:≤850mm Service Life:≥5 million times	/		Single Machine Core
141	Supermarket Revolving Gates RFID Round Cylinder	SWING02		Material:304 Stainless steel Size: 168*1050mm Input Voltage: 110/220VAC,50HZ Entrance Width:≤850mm Service Life:≥5million times	/	More Photo - >Click	/

S/N	Name	Model	Picture	Technical Parameters	/	Link	Remark
Sliding Turnstile							
142	Flap Sliding gate turnstile Octangle	SLIDING01		Material:304 Stainless steel Size: 1200*330*980mm Input Voltage: 110/220VAC,50HZ Entrance Width:≤550mm Service Life:≥5million times			Single Machine Core
		SLIDING02					Double Machine Core
143	Flap Sliding gate turnstile Whole Cover Arc	SLIDING101		Material:304 Stainless steel Size: 1200*330*980mm Input Voltage: 110/220VAC,50HZ Entrance Width:≤550mm Service Life:≥5million times			Single Machine Core
		SLIDING102					Double Machine Core
144	Flap Sliding gate turnstile Drum	SLIDING201		Material:304 Stainless steel Size: 1200*330*980mm Input Voltage: 110/220VAC,50HZ Entrance Width:≤550mm Service Life:≥5million times			Single Machine Core
		SLIDING202					Double Machine Core
145	Flap Sliding gate turnstile Rainbow	#NAME?		Material:304 Stainless steel Size: 1200*330*980mm Input Voltage: 110/220VAC,50HZ Entrance Width:≤550mm Service Life:≥5million times			Single Machine Core
		SLIDING302					Double Machine Core
146	Flap Sliding gate turnstile Luxury	SLIDING501		Material:304 Stainless steel Size: 1200*330*980mm Input Voltage: 110/220VAC,50HZ Entrance Width:≤550mm Service Life:≥5million times			Single Machine Core
		SLIDING502					Double Machine Core

S/N	Name	Model	Picture	Technical Parameters	/	Link	Remark
Speed Turnstile							
147	Speed Turnstile Gates Whole Cover Arc	TS-SPEED01		Material:304 Stainless steel Size: 1400*180*1000mm Input Voltage: 110/220VAC,50HZ Entrance Width:≤350mm Service Life:≥5million times			Single Machine Core
		TS-SPEED02					Double Machine Core
148	Speed Turnstile Gates Arched Type	TS-SPEED101		Material:304 Stainless steel Size: 1400*180*1000mm Input Voltage: 110/220VAC,50HZ Entrance Width:≤350mm Service Life:≥5million times			Single Machine Core
		TS-SPEED102					Double Machine Core
149	Speed Turnstile Gates Luxury	TS-SPEED201		Material:304 Stainless steel Size: 1400*180*1000mm Input Voltage: 110/220VAC,50HZ Entrance Width:≤350mm Service Life:≥5million times			Single Machine Core
		TS-SPEED202					Double Machine Core
150	Speed Turnstile Gates Round Cylinder	TS-SPEED301		Material:304 Stainless steel Size: 168*1000mm Input Voltage: 110/220VAC,50HZ Entrance Width:≤350mm Service Life:≥5million times			Single Machine Core
151	Drop Arm gate turnstile Octangle	TS-SPEED401		Material:304 Stainless steel Size: 1200*200*980mm Input Voltage: 110/220VAC,50HZ Entrance Width:≤600mm Service Life:≥5million times			Single Machine Core
		TS-SPEED402					Double Machine Core



S/N	Name	Model	Picture	Technical Parameters	/	Link	Remark
							
		Metal Detector Manufacturing Department					
③		Security Guard System Price List					
		sintronicdetector.com					
Hand Held Metal Detector		Vehicle Inspection Mirror		Walk Through Metal Detector		X Ray Baggage Scanner	
							
Page 53		Page 54		Page 55-59		Page 60	



S/N	Name	Model	Picture	Technical Parameters	/	Link	Remark
Hand Held Metal Detector							
152	Hand Held Metal Detector (Super Scanner)	HAND 01		<ol style="list-style-type: none"> 1. Detection sensitivity: detection of RMB one yuan coin, detection distance $\geq 90\text{mm}$ 2. Detection method: sound and light alarm. 3. Power supply: 9v square battery (6F22ND battery), with external charger function (Optional charger and battery) 4. Quiescent current: less than 26mA 5. Working current: sound and light less than 120mA 6. Working temperature: -5°C to 45°C 7. Dimensions: 415 * 85 * 45 mm 8. Net weight: 300g 9. Packing size: 500*260*440mm 	/	More Photo ->Click	/
153	Hand Held Metal Detector (GP)	HAND 02		<ol style="list-style-type: none"> 1. Detection sensitivity: detect RMB one yuan coin, the detection distance is $\geq 60\text{mm}$ 2. Alarm mode: sound and light synchronous alarm or vibration alarm. 3. Power supply: 9v square battery (6F22ND battery), external charger function (optional charger and battery) 4. Quiescent current: less than 7mA working current: sound and light less than 120mA 	/		/
154	Hand Held Metal Detector With Fashion design for exhibition	HAND 03		<p>Power Supply: External charging interface or 9Vfold battery (Battery is optional accessory)</p> <ol style="list-style-type: none"> 1. Power rate: 270 milliwatts 2. Working frequency: 22 kHz 3. Working current: $< 50\text{ mA}$ 4. Working voltage: 7-9v 5. Dimensions: 390 (length) * 840 (width) * 420 (thickness) mm <p>Detect Distance: 1-12cm Alarm Indication: Audio and Vibration at the same time.</p>	/	More Photo ->Click	/

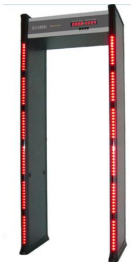

S/N	Name	Model	Picture	Technical Parameters	/	Link	Remark
Bottom Vehicle Inspection Mirror							
155	Vehicle Inspection Mirror with flash light	MIRROR-01		<ol style="list-style-type: none"> 1. Mirror surface: round 300*300mm acrylic high-strength shatterproof mirror surface, convex 2 times magnification effect, 1/2 the weight of ordinary glass mirror surface of the same size, with certain toughness, not easy to break, safe and durable, brightness and glass mirror surface different. Clamp-in fully enclosed round mirror with painted iron bottom can effectively prevent damage to the mirror caused by collision 2. Pull rod: lightweight aluminum rod, telescopic range 500-1100mm 3. Supplementary light source: 9 LED flashlight 4. Net weight: 1.1kg Gross weight: 1.6kg 5. Packing: 4 pcs/carton 6. Outer box packing: 560*430*390mm 7. Bag size: 540*340*110mm 	/	More Photo ->Click	/
156	Vehicle Inspection Mirror with flash light	MIRROR-INSPECTION02		<ol style="list-style-type: none"> 1. Mirror surface: round 300*300mm acrylic high-strength shatterproof mirror surface, convex 2 times magnification effect, 1/2 the weight of ordinary glass mirror surface of the same size, with certain toughness, not easy to break, safe and durable, brightness and glass mirror surface different. 			/

S/N	Name	Model	Picture	Technical Parameters	/	Link	Remark
Walk Through Metal Detector							
Single Zone							
157	Economical Single Zone Walk Through Metal Detector	DF01		<p>1. Detection procedure: level sensitivity adjustment, which can meet the needs of different occasions.</p> <p>2. Personnel passing rate: more than 40 person-times per minute.</p> <p>3. Power supply: 110-240V AC, 50/60Hz, power consumption: ≤ 18W.</p> <p>4. Testing standard: one yuan coin</p> <p>11. Display mode: digital tube display</p> <p>5. Working environment: -10℃ ~45℃, ≤95%RH.</p> <p>6. Channel size: 1980 (height) * 700 (width) * 300 (depth) mm</p> <p>7. Dimensions: 2220 (height) * 820 (width) * 400 (depth) mm</p> <p>8. Packing size: door panel: 2260*360*180mm (2 pieces/carton) Main box: 750*245*305mm (1pc/box).</p> <p>9. Net weight: 38kg/set Gross weight: 48kg/set</p> <p>10. Color: Available in iron gray, off-white, beige and black</p>	/	More Photo - >Click	/





S/N	Name	Model	Picture	Technical Parameters	/	Link	Remark
6 Zones							
158	Economical 6 Zone Walk Through Metal Detector	DF06		<p>1. Detection procedure: level sensitivity adjustment, which can meet the needs of different occasions.</p> <p>2. Personnel passing rate: more than 40 person-times per minute.</p> <p>3. Power supply: 110-240V AC, 50/60Hz, power consumption: ≤ 18W.</p> <p>4. Testing standard: one yuan coin</p> <p>5. Display mode: 6-zone digital tube display</p> <p>6. Working environment: -10℃ ~45℃, ≤95%RH.</p> <p>7. Channel size: 1980 (height) * 700 (width) * 500 (depth) mm</p> <p>8. Dimensions: 2220 (height) * 820 (width) * 580 (depth) mm</p> <p>9. Packing size: door panel: 2280*570*210mm (2 pieces/carton) Main box: 770*530*260mm</p>		More Photo - >Click	/
159	Lighting 6 Zone Walk Through Metal Detector	DF06LED		<p>1. Detection procedure: level sensitivity adjustment, which can meet the needs of different occasions.</p> <p>2. Personnel passing rate: more than 40 person-times per minute.</p> <p>3. Power supply: 110-240V AC, 50/60Hz, power consumption: ≤ 18W.</p> <p>4. Testing standard: one yuan coin</p> <p>5. Display mode: 6-zone digital tube display</p> <p>6. Working environment: -10℃ ~45℃, ≤95%RH.</p> <p>7. Channel size: 1980 (height) * 700 (width) * 500 (depth) mm</p> <p>8. Dimensions: 2220 (height) * 820 (width) * 580 (depth) mm</p> <p>9. Packing size: door panel: 2280*570*210mm (2 pieces/carton) Main box: 770*530*260mm</p>		More Photo - >Click	/





S/N	Name	Model	Picture	Technical Parameters	/	Link	Remark
160	Camera Interlinked 6 Zone Walk Through Metal Detector	DETECTOR-DF06CAMERA		Power Supply: 220V/110V Frequency:6.99-11khz Work Enviroment: -20℃ + 55℃ Power:<=30w Body size:2220*850*500mm Passage Width:2000*700*500mm Alarm Indication:Audio and Vibration at the same time. Display Panel:High quality digital tube with person number accessaccount 6 Zone detect sensibility class adjust RS485 Communication Port for Camera Inter-Linked 5.7Inch LCD Display Screen	/	More Photo - >Click	/
161	Luxury 6 Zone Digital Display Walk Through Metal Detector	DF06LUXURY		Power Supply: 220V/110V Frequency:6.99-11khz Work Enviroment: -20℃ + 55℃ Power:<=30w Body size:2210*835*500mm Passage Width:715mm Alarm Indication: Aarm Lightening ,Alarm vocie Display Panel:High quality digital tube with person number accessaccount 6 Zone detect sensibility class adjust	/	More Photo - >Click	/





S/N	Name	Model	Picture	Technical Parameters	/	Link	Remark
12 ZONE Walk Through Metal Detector							
162	12 Zone Walk Through Metal Detector	DF-12LUXURY		Power Supply: 220V/110V Frequency:6.99-11khz Work Enviroment: -20℃ + 55℃ Power:<=30w Body size:2210*835*500mm Passage Width:715mm Alarm Indication: Aarm Lightening ,Alarm vocie Display Panel:High quality digital tube with person number accessaccount 6 Zone detect sensibility class adjust	/	More Photo ->Click	/
18 ZONE Walk Through Metal Detector							
163	Economical 18 Zone Walk Through Metal Detector	DETECTOR-18DF ECONOMICAL		1. Detection procedure: level sensitivity adjustment, which can meet the needs of different occasions. 2. Personnel passing rate: more than 40 person-times per minute. 3. Power supply: 110-240V AC, 50/60Hz, power consumption: ≤ 18W. 4. Testing standard: one yuan coin 5. Display mode: 18-zone digital tube display	/	More Photo ->Click	/
164	18 Zone Walk Through Metal Detector with led Lighting	DF-018LED		1. Detection procedure: level sensitivity adjustment, which can meet the needs of different occasions. 2. Personnel passing rate: more than 40 person-times per minute. 3. Power supply: 110-240V AC, 50/60Hz, power consumption: ≤ 18W. 4. Testing standard: one yuan coin 5. Display mode: 18-zone 6-inch large LCD display 6. Working environment: -10℃ ~45℃, ≤95%RH.	/	More Photo ->Click	/





S/N	Name	Model	Picture	Technical Parameters	/	Link	Remark
33 ZONE Walk Through Metal Detector							
165	33 Zone Walk Through Metal Detector	DF-033		<ol style="list-style-type: none"> 1. Detection procedure: level sensitivity adjustment, which can meet the needs of different occasions. 2. Personnel passing rate: more than 40 person-times per minute. 3. Power supply: 110-240V AC, 50/60Hz, power consumption: ≤ 18W. 4. Testing standard: one yuan coin 5. Display mode: 33-zone 2.5-inch small LCD screen 6. Working environment: -10℃ ~45℃, ≤95%RH. 	/	More Photo - >Click	/
45 Zone Walk Through Metal Detector							
166	45 Zone Walk Through Metal Detector 400 Level	DF-045		<ol style="list-style-type: none"> 1. Detection procedure: level sensitivity adjustment, which can meet the needs of different occasions. 2. Personnel passing rate: more than 40 person-times per minute. 3. Power supply: 110-240V AC, 50/60Hz, power consumption: ≤ 18W. 4. Testing standard: one yuan coin 5. Display mode: 6-inch large LCD display in 45 areas 6. Working environment: -10℃ ~45℃, ≤95%RH. 7. Channel size: 2000 (height) * 700 (width) * 600 (depth) mm 	/	More Photo - >Click	/



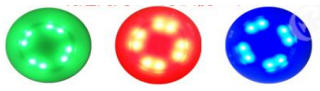
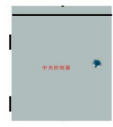

S/N	Name	Model	Picture	Technical Parameters	/	Link	Remark
X Ray Baggage Scan Machine							
167	X Ray Baggage Scan Machine	X RAY-5030A		<p>Basic parameters Channel size: 505*305mm (width*height) Power belt speed: 0.22m/s Portal load: 100kg (uniform load) Passage: > 10mm steel plate Line split force:> 38AWG Space resolution: horizontal/vertical φ1.0mm</p> <p>X -ray source Control interface: Simulation interface Tube voltage: 80kV (adjustable) Tube current: 0.6 ~ 1.2ma (adjustable) Cooling method: sealing oil and cooling, industrial fan cooling Work Zhou Ming: 100 %, no top heat Protection function: over pressure, overcurrent, over -temperature protection Radiation safety index Dose rate: <0.5 μgy/h (5cm from the shell) Single dose: <1.0 μgy Safety: Safety of film, chip, and electronic products Radiation Protection: The passage and export of the channel use 0.5mmpb dual -layer Environmental protection lead curtain protection, the raw body uses 2 to 6mm lead plate protection to ensure that the peripheral radiation of the equipment meets national security standards</p>	/	More Photo ->Click	/

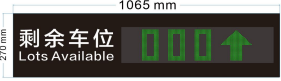

S/N	Name	Model	Picture	Technical Parameters	/	Link	Remark
ENJOY A SECURITY GUARD SYSTEM							
④	PGS Manufacturing Department						
	Parking Guidance System Price List						
	sintronicparking.com						
Integrated Parking Guidance System				Split Parking Guidance System			
							
Page 62-63				Page 64-65			
3 in 1 parking guidance system(OEM)				Camera base parking guidance system			
							
Page 66-68				Page 69-70			



S/N	Name	Model	Picture	Technical Parameters	/	Link	Remark
ENABLING A SAFER SOCIETY AND SMARTER PARKING GUIDANCE							
Integrated Ultrasonic Parking Guidance System (Detector and indicator is share in 1)							
168	Integrated Ultrasonic Detector	ID201		Front-mounted ultrasonic Detector for car bay status detection, including indicator lights Working power:24V		More Photo ->Click	/
169	Central controller With power box	CENTER201		Independent offline control and one unit of main control box can support max 64 units of nod control box connection to the system Working power:24V Communication:Tcp/ip,RS485		More Photo ->Click	/
170	AREA Controller with Power Box	AREA201		1.Each unit of nod controller have 4 units rs485 wiring line and each unit of nod controller advise to wire not max than 60 pcs detector. 2.Working Power:24V Communication:RS485		More Photo ->Click	/
171	Single Direction Indoor LED Display	01SCREEN201		Single Direction Indoor led display for integrated parking guidance system Lighting box can be customized		More Photo ->Click	/
172	2 Directions Indoor LED Display	02SCREEN201		2 Directions Indoor led display for integrated parking guidance system Lighting box can be customized		More Photo ->Click	/

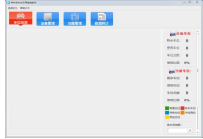

S/N	Name	Model	Picture	Technical Parameters	/	Link	Remark
173	Outdoor Led display 3FLOORS(B1, B2,B3)	03OUTSCREEN-201		Size: (can be customized according to customer requirements) 1.One-Direction 1065*270*90mm Power input: AC 110~240V 2 directions 1370*270*90mm Power consumption: ≤15W (one-way) 3 directions 1690*270*90mm Environmental humidity: 30%--90% (relative humidity) Communication: RS485 Light source: Red/green LED lamp Beads communication	/	More Photo ->Click	/
174	Remoter for ultrasonic sensor setting	REMOTER201		1.Setting and read the detector address, distance and mode, saving time and money 2.Detector distance to ground>1.1Meter		More Photo ->Click	/
175	RS485 Terminal for sensor connection	485Terminal		485 wiring terminal board The resistance value of 100 meters cannot exceed 10 ohms		More Photo ->Click	/
176	RS485 Tool for led display setting	485 LEDTOOL		Set the address code and direction of the display screen, and also set the probe parameters		More Photo ->Click	/
177	Software	SOFTWARE201		Integrated Parking Guidance Software		Software Download ->Click	/



S/N	Name	Model	Picture	Technical Parameters	/	Link	Remark
Split parking guidance system(1 detector wiring to 1 indicator)							
178	Split Type Ultrasonic Detector	SD101		Front-mounted ultrasonic detector, indicator light is separate, one for each parking space Working Power:24V		More Photo - >Click	/
179	Indicator For Split Type Ultrasonic Detector	INDICATOR101		Indicator Light For Split Type Ultrasonic Detector		More Photo - >Click	/
180	Central controller With box	CENTER101		Independent offline control and one unit of main control box can support max 64 units of nod control box connection to the system Working power:24V		More Photo - >Click	/
181	AREA Control Box	AREA 101		Each can be connected to 60 units parking bays			
182	Single Direction Indoor Scree	01SCREEN101		Single Direction Indoor led display for split parking guidance system Lighting box can be customized		More Photo - >Click	/
183	2 Direction Indoor Screen	02SCREEN101		2 Directions Indoor led display for integrated parking guidance system Lighting box can be customized			/





S/N	Name	Model	Picture	Technical Parameters	/	Link	Remark
184	OUTDOOR SCREEN 3 FLOORS(B1,B2,B3)	03OUTSCREEN101		Size: (can be customized according to customer requirements) 1.One-Direction 1065*270*90mm Power input: AC 110~240V 2 directions 1370*270*90mm Power consumption: ≤15W (one-way) 3 directions 1690*270*90mm Environmental humidity: 30%--90% (relative humidity) Communication: RS485 Light source: Red/green LED lamp Beads communication distance: ≤300m	/	More Photo - >Click	/
185	Remoter for ultrasonic sensor	REMOTER101		1.Setting and read the detector address, distance and mode, saving time and money 2.Detector distance to ground>1.1Meter		More Photo - >Click	/
186	RS485 Terminal	485TERMINAL		485 wiring terminal board The resistance value of 100 meters cannot exceed 10 ohms		More Photo - >Click	/
187	LED Display RS485 Tool	485LEDTOOL		Set the address code and direction of the display screen, and also set the probe parameters		More Photo - >Click	/
188	Software	SOFTWARE101		Split Parking guidance software		Software Download - >Click	/



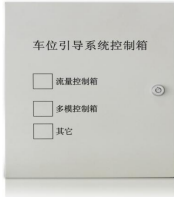





S/N	Name	Model	Picture	Technical Parameters	/	Link	Remark
OEM 3 detector wiring to 1 indicator Ultrasonic Parking Guidance System							
189	OEM Detector For 3 In 1 Parking Guidance System	SD301		Body shell structure/material: ABS plastic Body color: white Dimensions: 98mmx80mmx37mm Communication mode: RS485 Working voltage: DC12V Average power consumption: 30mA		More Photo - >Click	/
190	OEM Indicator For 3 In 1 Detector	INDICATOR301		High -brightly shot hemisphere LED two -color indicator (gem red/emerald green) Dimensions of the shape: diameter 70mmx60mm Working voltage: DC12V Average power consumption: 30mA		More Photo - >Click	/
191	OEM Circuit Board	CIRCUIT301		OEM circuit board for 3 detector share 1 indicator output and input signal control		More Photo - >Click	/

S/N	Name	Model	Picture	Technical Parameters	/	Link	Remark
192	OEM Controller For 3 in 1 Parking System	CONTROLLER301		<p>Properties: Built -in information prompt display, real -time fault processing and data isolation function. The system adopts the latest leading Internet communication technology to achieve precise guidance instructions of points and points. Formula setting</p> <p>Working voltage: AC220-240V Output power: DC12V/ 8A Communication method: RS485 Max support 64 units detector for each area controller and usually advised 40 units detector wiring to one area controller</p>	/	More Photo ->Click	/
193	OEM Single Direction Indoor Led Display	01SCREEN301		<p>Body structure and material: special#25 champagne brushed all -aluminum alloy fuselage Panel material:#5 Black all -tempered glass panel Dimensions: 860mmx210mmx110mm Single weight: about 10kg Communication:RS485 Power Supply:220-240V</p>	/	More Photo ->Click	/



S/N	Name	Model	Picture	Technical Parameters	/	Link	Remark
194	OEM Outdoor IED Display	03OUTSCREEN 301		<p>Size: (can be customized according to customer requirements)</p> <p>One-way 1065*270*90mm</p> <p>Power Supply: AC 110~240V</p> <p>Two-way 1370*270*90mm</p> <p>Power consumption: ≤15W (one-way)</p> <p>Three-way 1690*270*90mm</p> <p>Environmental humidity: 30%--90% (relative humidity)</p> <p>Appearance material: cold plate laser cutting and baking varnish</p> <p>Communication method: RS485</p> <p>Light source: Red/green LED lamp beads</p> <p>Communication distance: ≤300m</p> <p>SET</p>	/	More Photo - >Click	/
195	RS485 to Usb Conveter	485-USB		RS485 to Usb Conveter For Signal Communication to pc software	/	None	/

S/N	Name	Model	Picture	Technical Parameters	/	Link	Remark
Camera parking guidance system (3 detector wiring to 1 indicator)							
196	Camera Detector	V-CD301		Camera Detector Built-in license plate recognition algorithm, can identify 1-3 parking Spaces, built-in LED indicator traffic light two-color display Power Supply:24V		More Photo ->Click	/
197	Indicator For Camera Detector	V-INDICATOR301		indicator 1 video detector can be connected to 1-3 parking indicator lights, RS485		More Photo ->Click	/
198	Video Parking Controller With Power Box	V-CONTROLLER		Video parking with power box 220v-240v One parking guidance controller device box can connect to 1-16 camera detectors		More Photo ->Click	/

S/N	Name	Model	Picture	Technical Parameters	/	Link	Remark
199	Single Direction Indoor Display Screen	V-01SCREEN301		770 * 210 * 80mm, including empty space light box Light box font is customizable	/	More Photo - >Click	/
200	2Direction Indoor Display Screen	V-02SCREEN301		1080*210*80mm, including empty space light box Light box font is customizable		More Photo - >Click	/
201	2 Direction Indoor Display Screen	V-03SCREEN301		1460*210*80mm, including empty space light box Light box font is customizable		More Photo - >Click	/
202	Car serching kiosk	V-KIOSK301		car serching kiosk 21.5'touch screen, TCP / IP interface. Installed on the stairs and at the elevator openings. One unit is expected to be installed on each layer of 8 floors		More Photo - >Click	/

S/N	Name	Model	Picture	Technical Parameters	/	Link	Remark
⑤							
	Parking System Manufacturing Department						
	Parking Ticketing System Price List						
	sintronicparking.com						
Car Plate Recognition Camera				RFID Parking Controller	RFID Parking Reader		
							
Page 72				Page 73	Page 73		
Barrier Boom Gate				Parking Ticket Box	Payment Machine		
							
Page 74-76				Page 77	Page 77		
Card Dispenser&Collector				Loop Detector			
							
Page 78				Page 78-79			



S/N	Name	Model	Picture	Technical Parameters	/	Link	Remark
Car Plate Recognition Camera							
203	Car plate recognition Camera	PS-01CAMERA		<ul style="list-style-type: none"> ◇ Ultra HD 4 million pixels (1440P); ◇ All-day vehicle capture rate is higher than 99.9%; ◇ All-day license plate recognition rate is higher than 95%; ◇ Support cloud control function for parameter configuration, video preview and remote upgrade; ◇ Adopt video compression technology H.264 for video encoding, and capture frames using JPEG encoding; . ◇ Support three detection methods: coil detection, video detection, coil detection + video detection ; ◇ Support OSD information overlay function, support video 1 picture overlay watermark; ◇ Support white list import and export function, can do fuzzy matching on white list; Support OEM For Global Country ◇ Support configuration file import backup ; ◇ Support manual key reset, you can restore the initial IP address, user name, password and restore the default factory configuration with one click ; ◇ Support cloud intercom ; 	/	More Photo ->Click	SDK,HTTP API for linkage to parking payment system

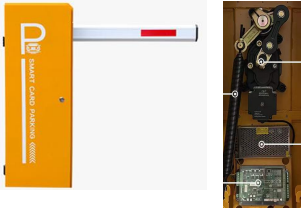
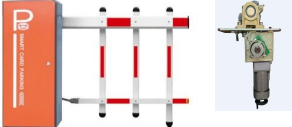

S/N	Name	Model	Picture	Technical Parameters	/	Link	Remark
RFID Parking Controller							
204	RFID Parking Ticketing Controller	PS-RFID TCP300		Working voltage: DC12V Working environment temperature: -25°C-60°C Relative humidity: =< 95% Card reader interface: WG26 Communication interface: RS485 Communication baud rate: 4800b/s Maximum communication distance: 1200 meters User Information: 6000 Offline Storage Record Capacity: 10000 Card type: optional IC, ID Card reading distance: 5 ~ 10cm (IC card)	/	More Photo ->Click	Parking management software in english version
Parking Ticketing Reader							
205	Entry Station RFID Reader	PS-ETYREADER		Entry Station RFID Parking Ticketing Reader IC Type 13.56Mhz	/	More Photo ->Click	IC
206	Exit Station RFID Reader	PS-EXTREADER		Exit Station RFID Parking Ticketing Reader IC Type 13.56Mhz	/	More Photo ->Click	IC

S/N	Name	Model	Picture	Technical Parameters	/	Link	Remark
Barrier Boom Gate							
207	AC Motor Stright Pole Boom Gate	BG-AC100		<p>Barrier Boom Gate Octagonal Powder Coated Aluminum .50-60W Single phase asynchronous AC motor with over heat protection function .Brake rod landing time 0.2~6s .Work Enviroment -25~+60 Degree Relative humidity less than 95%& no condensation, Gate center to off-ground height 885mm Lifeleaf time:5 million times Size: 270*340*1000mm Thickness:1.5</p>	/	More Photo ->Click	<p>Gate Only Single Spring Without Pole (Bg-AC100)</p> <p>AC Motor Gate with 1-3 meters Pole Single Spring(Bg-AC103)</p> <p>High Power AC Motor Gate with 1-4meters Pole Single Spring(Bg-</p> <p>High Power AC Motor Gate with 1-5 meters Pole 2 Spring(Bg-AC105)</p> <p>Pure copper High Power AC Motor Gate with 1-6 meters Pole 2 Spring(Bg-AC106)</p>

S/N	Name	Model	Picture	Technical Parameters	/	Link	Remark
208	Brushless Motor Stright Pole Boom Gate	BG-BRULSS 100		Barrier Boom Gate Octagonal Powder Coated Aluminum .50-60W Single phase asynchronous Brushless motor with over heat protection function .Brake rod landing time 0.2~6s .Work Enviroment -25~+60 Degree Relative humidity less than 95%& no condensation, Gate center to off-ground height 885mm Lifeleaf time:5 million times Size: 270*340*1000mm Thickness:1.5	/	More Photo - >Click	Gate Only Single Spring Without Pole (BG- Brushless Motor Gate with 1-3 meters Pole 2 Spring(BG- Brushless Motor Gate with 1-4 meters Pole 2 Spring(BG-BRULSS104) Brushless Motor Gate with 1-5 meters Pole 2 Spring(BG-BRULSS105) High Power Brushless Motor Gate with 1-6 meters Pole 2 Spring(BG-BRULSS106)
209	AC Motor Barrier Boom Gate	BG-AC200		Barrier Boom Gate Octagonal Powder Coated Aluminum .50-60W Single phase asynchronous AC motor with over heat protection function .Brake rod landing time 2.5~6s .Work Enviroment -25~+60 Degree Relative humidity less than 95%& no condensation, Gate center to off-ground height 885mm Lifeleaf time:5 million times Size: 285*340*980 Thickness:2.0 Extra Thickness Steel Mounted Chip core motor and be stable running the 6 meter barrier rod	/	None	Gate Only (Frequency Changeable) (BG-AC200) Gate with 1-3 meters barrier AC motor (BG-AC203) Gate with 1-4 meters barrier BG-AC204 Gate with 1-5 meters Barrier BG-AC205 Gate with 1-6 meters Barrier BG-AC206

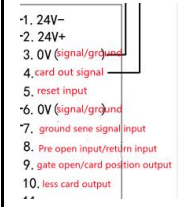
S/N	Name	Model	Picture	Technical Parameters	/	Link	Remark
210	Brushless Motor Barrier Boom Gate	BG-BRULSS200		<p>Barrier Boom Gate Octagonal Powder Coated Aluminum .50-60W Single phase asynchronous Brushless motor with over heat protection function .Brake rod landing time 2.5~6s .Work Enviroment -25~+60 Degree Relative humidity less than 95%& no condensation, Gate center to off-ground height 885mm Lifeleaf time:5 million times Size: 285*340*980 Thickness:2.0 Extra Thickness Steel Mounted Chip core motor and be stable running the 6 meter barrier rod</p>	/	None	Brushless motor Gate with 1-3 meters barrier AC motor (BG-BRULSS203)
							High Power Brushless motor Gate with 1-4 meters barrier AC motor (BG-BRULSS204)
							High Power Brushless motor Gate with 1-5 meters barrier BG-BRULSS205
							High Power Brushless motor Gate with 1-6 meters Barrier BG-BRULSS206

S/N	Name	Model	Picture	Technical Parameters	/	Link	Remark
Parking Ticketing Box							
211	Ticket Box	TB -1325		Ticket Box for issue or return ic/id card Size:32*44*1325mm Available for card size of 85*54+-0.5mm with thickness of 0.2-2.4mm (adjustable)The default factory set up is 0.8mm	/	None	/
Parking Ticketing RFID Card Dispenser/Collector							
212	RFID card issue machine	CI-01		Available for card size of 85*54+-0.5mm with thickness of 0.2-2.4mm (adjustable)The default factory set up is 0.8mm	/	None	For use the functions of once the card been collected and the gate open Pls do 03 ov wire to GND,09 wire to boom gate open signal
213	RFID card collect machine	CC-01		Available for card size of 85*54+-0.5mm with thickness of 0.2-2.4mm (adjustable)The default factory set up is 0.8mm Support link to boom gate open once the card is been collected		None	 <ul style="list-style-type: none"> -1. 24V- -2. 24V+ 3. 0V (signal/ground) 4. card out signal 5. reset input -6. 0V (signal/ground) -7. ground sense signal input 8. Pre open input/ret/m input 9. gate open/card position output 10. less card output ..

S/N	Name	Model	Picture	Technical Parameters	/	Link	Remark
Parking Ticketing Payment Machine							
214	Auto Payment Machine	PM01		AUTOMATIC Payment machine with touch screen and have windows system support linkage to bank payment system between camera and boom gate	/	None	Card payment machine
Loop Sensor							
215	Ground Sense Vehicle Loop Detector	LOOP-01		Supply voltage:230V AC , 115V AC, 24V DC/AC, 12V DC/AC (Please the label on the detector for more information) Voltage tolerance AC:+10% / -15% Voltage tolerance: DC±15% Power Consumption:4.5VA Output relays:240V/5A Operating temperature:-20°C to +65°C Storage temperature:-40°C to		None	/

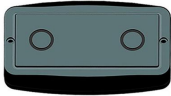
S/N	Name	Model	Picture	Technical Parameters	/	Link	Remark
216	Radar Anti Fall Loop Detector	RADAR-01		Transmit frequency:24.00-24.25 GHz Output power:10dBm Update rate:20ms Power consumption:1.5W Detection characteristics Detection distance:0.1~10meters Detection target:human, vehicle Distinguish following cars:0.6 meters Antenna characteristics Beam width/TX Horizontal in 22°, Elevation in 37° Hardware characteristics Supply voltage:6~24V DC Supply current:0.12A Operating temperature:-40~+85	/	None	/

S/N	Name	Model	Picture	Technical Parameters	/	Link	Remark
-----	------	-------	---------	----------------------	---	------	--------

Pengrunda Commercial Plaza, Shen

Pengrunda Global Fumao Plaza
No reviews
Clothing store · 广东省 深圳市楼 4019 Sintronictech
Delivery

皇庭廣場
4.1 ★★★★★ (410)
Shopping mall · G3M5+FW4, Fuhua Rd 3
Urban mall for upscale shopping & dining
Closed · Opens 10 AM · +86 755 8288 1111
On-site services

Xihua Palace Shopping Center
3.8 ★★★★★ (28)
Shopping mall · 步行街
Indoor market for electronics & more
Closed · Opens 10 AM · +86 755 2517 1388

Xingwanda Square
No reviews
Shopping mall · 419 Guanlan Blvd
Closed · Opens 10 AM

Pengrunda Global Fumao Plaza
鹏润达·环球服贸广场
Clothing store ·

Overview About

Directions Save Nearby Send to phone Share

✓ Delivery

China, 4, Longhua District, Shenzhen, CN 广东省 深圳市楼4019 邮政编码: 518131

Claim this business



We Keep Growing In Global Market

Thanks For Your Kind Support